

# Solenoid valve(5/2 way,5/3 way)

## 7V Series

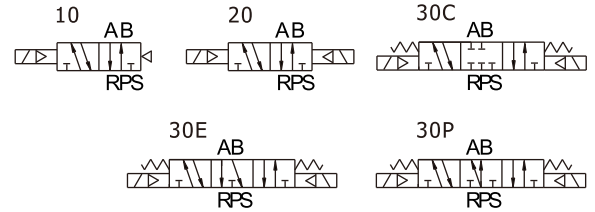

### Ordering code

**7V 2 10 J 5/16 B 050 T**



① Model	7V : Solenoid valve (5/2, 5/3 way)			
② Code	05 : 0500 Series	1 : 100 Series	2 : 200 Series	3 : 300 Series
③ Valve type	10 : Single solenoid 5/2 way		20 : Double solenoid 5/2 way	
	30C : Double solenoid 5/3 way closed center		30E : Double solenoid 5/3 way exhaust center	
	30P : Double solenoid 5/3 way pressure center			
④ Port type	Blank : Thread type		J : Tube type[Note1]	
⑤ Port size	Thread	M5: M5	06 : 1/8"	08 : 1/4"
	Tube	5/32 : Φ5/32	5/32 : Φ5/32; 1/4 : Φ1/4; 5/16 : Φ5/16	5/16 : Φ5/16; 3/8 : Φ3/8
⑥ Voltage	A: AC220V		B: DC24V	C: AC110V F: DC12V
⑦ Line length	050 : 0.5m		200 : 2.0m	
⑧ Thread type	-		T: NPT	

[Note 1]: The bottom ports of solenoid valve with tube type are oval, without tread type options and can only install with a manifold.

## Specification

Model	7V0510	7V0520	7V0530	7V110	7V120	7V130
Port size [Note1]	In=Out=Exhaust=M5			In=Out=Exhaust=1/8"		
	Tube type Port A=Port B=Φ5/32			Port A=Port B=Φ5/32(or Φ1/4 or Φ5/16)		
Orifice size (Cv value) [Note4]	M5:3.4mm <sup>2</sup> (0.2)		7V0530CM5: 2.2mm <sup>2</sup> (0.13)	06:8.0mm <sup>2</sup> (0.47)		7V130C06: 7.0mm <sup>2</sup> (0.41)
Weight	30g	45g	50g	80g	90g	100g
Model	7V210	7V220	7V230	7V310	7V320	7V330
Port size [Note1]	In=Out=1/4" Exhaust=1/8"			In=Out=3/8" Exhaust=1/4"		
	Tube type Port A=Port B=Φ5/16(or Φ3/8)			-		
Orifice size (Cv value) [Note4]	08:14.7mm <sup>2</sup> (0.87)		7V230C08: 10.8mm <sup>2</sup> (0.64)	10:38.4mm <sup>2</sup> (2.26)		7V330C10: 30.5mm <sup>2</sup> (1.8)
Weight	120g	135g	145g	230g	265g	305g
Fluid	Air(to be filtered by 40μm filter element)					
Acting	Pilot					
Operating pressure	7V0530/7V130 7V230/7V330		29~114psi(0.2~0.8MPa)			
	Others		21~114psi(0.15~0.8MPa)			
Proof pressure	175psi(1.2MPa)					
Temperature	-20~70°C					
Material of body	Aluminum alloy					
Lubrication [Note2]	Not required					
Exhaust type of pilot valve	Main valve and pilot valve is centralized exhaust					
Max. frequency [Note3]	5 cycle/sec		3 cycle/sec		5 cycle/sec 3 cycle/sec	

[Note1] NPT thread is available.

[Note2] Once lubricated air is used, continue with same medium to optimise valve life span. Lubricants like ISO VG32 or equivalent are recommended.

[Note3] The maximum actuation frequency is in the no-load state.

[Note4] Equivalent orifice S and Cv are all calculated from the flow rate data.

# Solenoid valve(5/2 way,5/3 way)

## 7V Series

### Coil specification

Item	Specification			
	AC220V	AC110V	DC24V	DC12V
Standard voltage	AC220V	AC110V	DC24V	DC12V
Scope of voltage	AC : +15% ~-10%		DC : ±10%	
Power consumption	1.1VA		0.9W	
Protection	Dustproof			
Temperature classification	F Class			
Electrical entry	Terminal			
Activating time	0.05 sec and below			

### Product feature

1. Electrical entry is terminal, horizontal and vertical insertion can freely switch.
2. Inner exhaust structure to collect pilot airflow, and then exhaust intensively from R, S port.
3. Die-cast molding with aluminum alloy for body. The shape of cavity is reasonable, which can increase valve's flow.
4. Threaded type and quick connector type are optional, and can integrate manifold to form valve group to save space.

### Inner structure

7V110

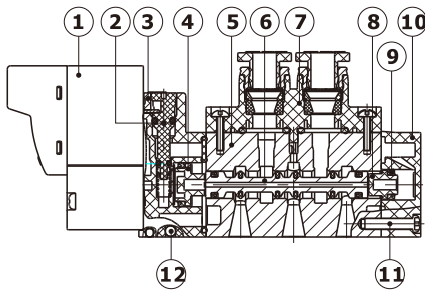

7V120

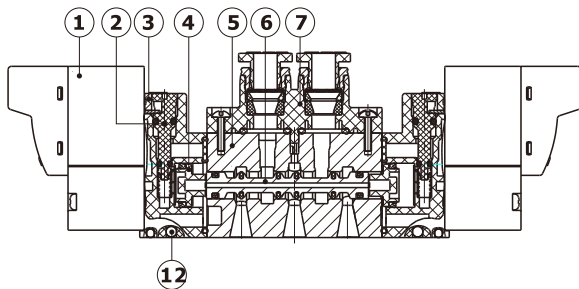

7V130C

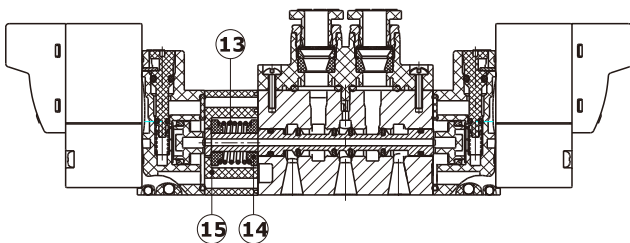

No.	Item	No.	Item	No.	Item
1	Pilot valve	6	Spool	11	Bolt
2	Manual override	7	Connecting block	12	Steel ball
3	Pilot kit	8	Little piston	13	Spring
4	Big piston	9	Gasket	14	Return holder
5	Body	10	Bottom cover	15	Side cover

### Flow chart

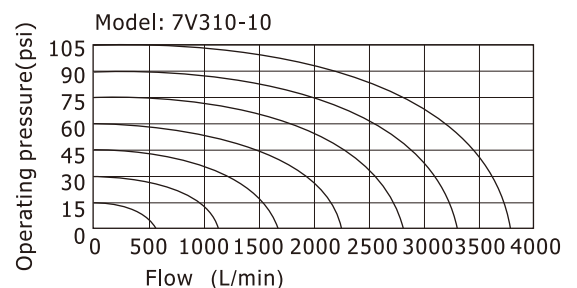
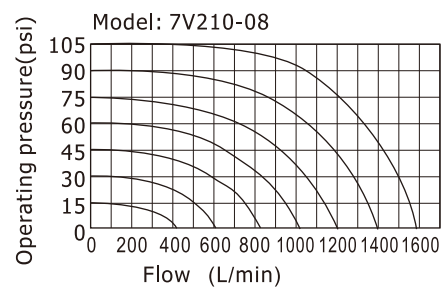
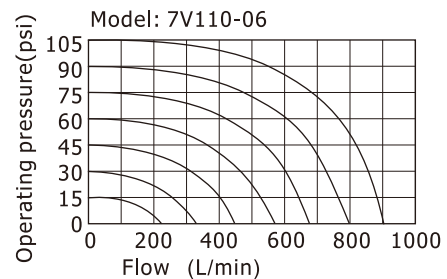
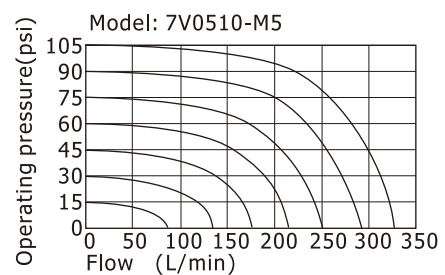

The data in flow rate chart are obtained from AirTAC lab.

# Solenoid valve(5/2 way,5/3 way)

## 7V Series

### Dimensions

7V0510

7V110

7V210

7V310

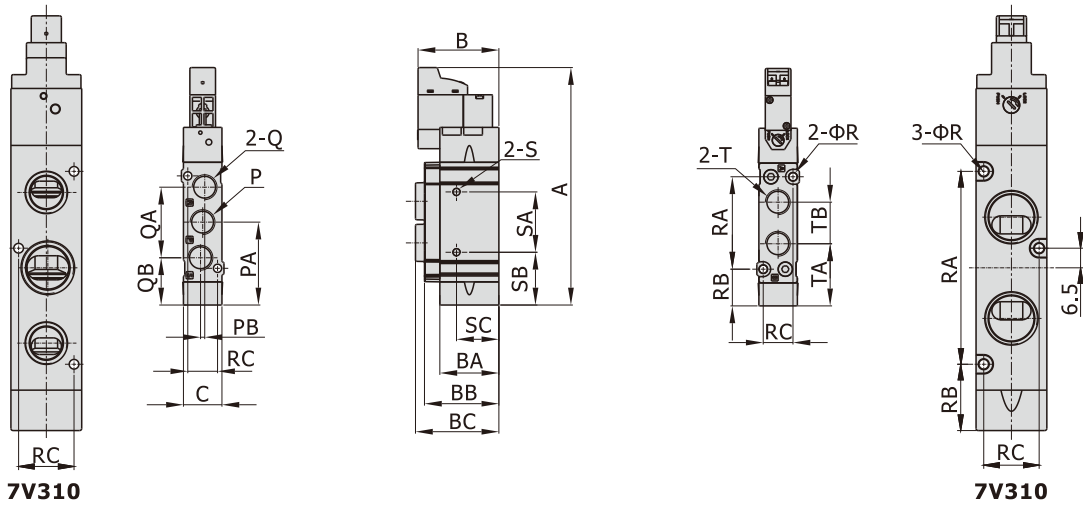

#### Port size

[Unit: inch]

Model\Item	P	Q	T
7V0510M5	M5X0.8	M5X0.8	M5X0.8
7V0510J5/32	Oval	Oval	Φ5/32(tube)
7V11006	1/8"	1/8"	1/8"
7V110J5/32			Φ5/32(tube)
7V110J1/4	Oval	Oval	Φ1/4(tube)
7V110J5/16			Φ5/16(tube)
7V21008	1/4"	1/8"	1/4"
7V210J5/16	Oval	Oval	Φ5/16(tube)
7V210J3/8			Φ3/8(tube)
7V31010	3/8"	1/4"	3/8"

[Unit: mm]

Model\Item	A	B	BA	BB	BC	C	PA	PB	QA	QB	TA	TB	R	RA	RB	RC	S	SA	SB	SC		
7V0510M5	73	30.5	18.5	23	23.5	10	22.5	1	19	13	17.5	10.5	2.1	21.4	12	8.6	M3X0.5dp3	9.5	17.8	4		
7V0510J5/32					32.5												-				-	-
7V11006	92.5	32	23	29	32.5	15	32.5	1.6	27.2	18.5	24	16.2	3.2	36	14.5	11.6	M3X0.5dp3	23.5	20.5	16.5		
7V110J5/32					38.2																	
7V110J1/4					40																	
7V110J5/16					41.5																	
7V21008	106	33.5	28	34	40.5	18	39	3	36	21	29	20	4.3	42	18	13.6	M4X0.7dp5	20	29	7		
7V210J5/16					46.5																	
7V210J3/8					49																	
7V31010	137.5	46	-	-	46	23.5	54	0.5	50	29	37	33.5	3.2	64	22	18.4	Φ4.3	25	41.5	8		

[Note]: The bottom of solenoid valve with tube type are oval port and can only install with manifold (no side installation hole "S").

# Solenoid valve(5/2 way,5/3 way)

## 7V Series

**7V0520**

**7V120**

**7V220**

**7V320**

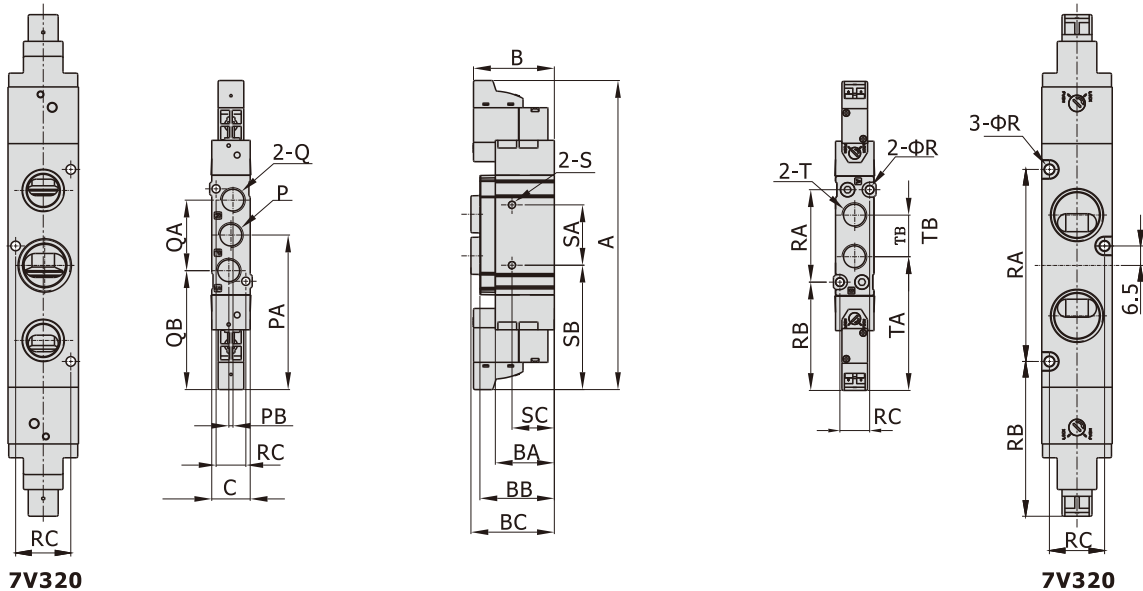

### Port size

[Unit: inch]

Model \ Item	P	Q	T
7V0520M5	M5X0.8	M5X0.8	M5X0.8
7V0520J5/32	Oval	Oval	Φ5/32(tube)
7V12006	1/8"	1/8"	1/8"
7V120J5/32			Φ5/32(tube)
7V120J1/4	Oval	Oval	Φ1/4(tube)
7V120J5/16			Φ5/16(tube)
7V22008	1/4"	1/8"	1/4"
7V220J5/16	Oval	Oval	Φ5/16(tube)
7V22008J3/8			Φ3/8(tube)
7V32010	3/8"	1/4"	3/8"

[Unit: mm]

Model \ Item	A	B	BA	BB	BC	C	PA	PB	QA	QB	TA	TB	R	RA	RB	RC	S	SA	SB	SC
7V0520M5	101.5	30.5	18.5	23	23.5	10	50.5	1	19	41	45.5	10.5	2.1	21.4	12	8.6	M3X0.5dp3	9.5	17.8	4
32.5					-												-	-		
7V12006	120.5	32	23	29	32.5	15	60.5	1.6	27.2	46.5	52	16.2	3.2	36	14.5	11.6	M3X0.5dp3	23.5	48.5	16.5
7V120J5/32					38.2												-	-	-	
7V120J1/4					40												-	-	-	
7V120J5/16					41.5												-	-	-	
7V22008	134	33.5	28	34	40.5	18	67	3	36	49	57	20	4.3	42	18	13.6	M4X0.7dp5	20	57	7
7V220J5/16					46.5												-	-	-	
7V22008J3/8					49												-	-	-	
7V32010	167	46	-	-	46	23.5	83.5	0.5	50	58.5	67	33.5	3.2	64	51.5	18.4	Φ4.3	25	71	8

[Note]: The bottom of solenoid valve with tube type are oval port and can only install with manifold (no side installation hole "S").

# Solenoid valve(5/2 way,5/3 way)

## 7V Series

7V0530

7V130

7V230

7V330

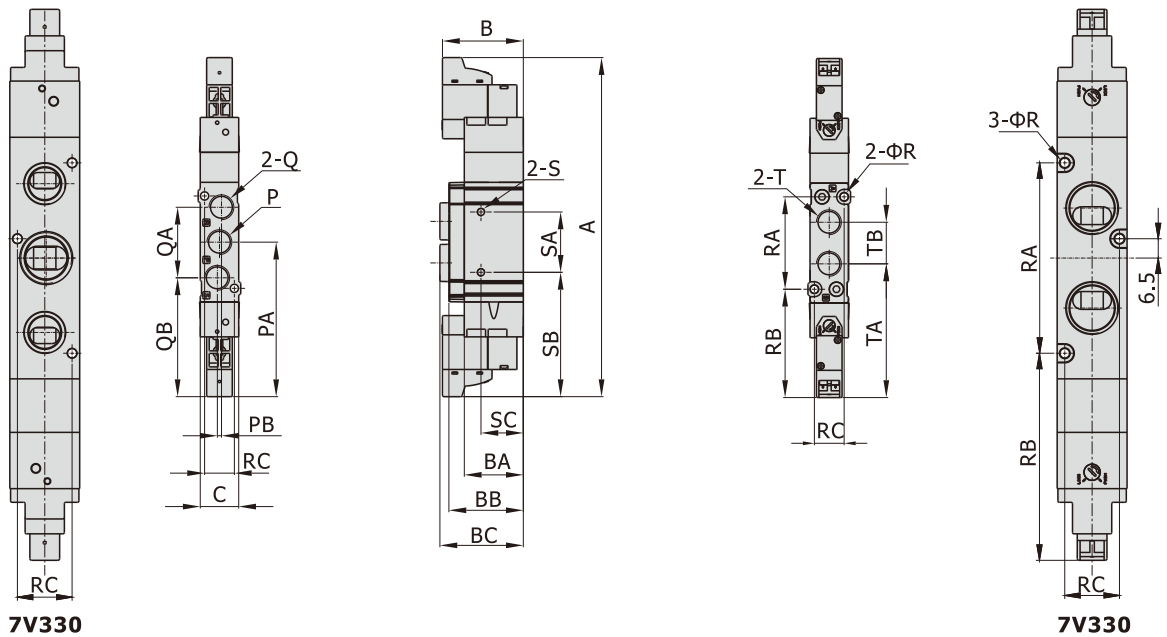

### Port size

[Unit: inch]

Model\Item	P	Q	T
7V0530M5	M5X0.8	M5X0.8	M5X0.8
7V0530J5/32	Oval	Oval	Φ5/32(tube)
7V13006	1/8"	1/8"	1/8"
7V130J5/32	Oval	Oval	Φ5/32(tube)
7V130J1/4			Φ1/4(tube)
7V130J5/16			Φ5/16(tube)
7V23008	1/4"	1/8"	1/4"
7V230J5/16	Oval	Oval	Φ5/16(tube)
7V230J3/8			Φ3/8(tube)
7V33010	3/8"	1/4"	3/8"

[Unit: mm]

Model\Item	A	B	BA	BB	BC	C	PA	PB	QA	QB	TA	TB	R	RA	RB	RC	S	SA	SB	SC
7V0530M5	110	30.5	18.5	23	23.5	10	50.5	1	19	41	45.5	10.5	2.1	21.4	12	8.6	M3X0.5dp3	9.5	45.8	4
7V0530J5/32					32.5												-	-	-	
7V13006	132	32	23	29	32.5	15	60.5	1.6	27.2	46.5	52	16.2	3.2	36	14.5	11.6	M3X0.5dp3	23.5	48.5	16.5
7V130J5/32					38.2												-	-	-	
7V130J1/4					40												-	-	-	
7V130J5/16					41.5												-	-	-	
7V23008	147	33.5	28	34	40.5	18	67	3	36	49	57	20	4.3	42	18	13.6	M4X0.7dp5	20	57	7
7V230J5/16					46.5												-	-	-	
7V230J3/8					49												-	-	-	
7V33010	185	46	-	-	46	23.5	101.5	0.5	50	76.5	85	33.5	3.2	64	69.5	18.4	Φ4.3	25	89	8

[Note]: The bottom of solenoid valve with tube type are oval port and can only install with manifold (no side installation hole "S").

# Solenoid valve(5/2 way,5/3 way)

## Mounting bracket for 7V Series

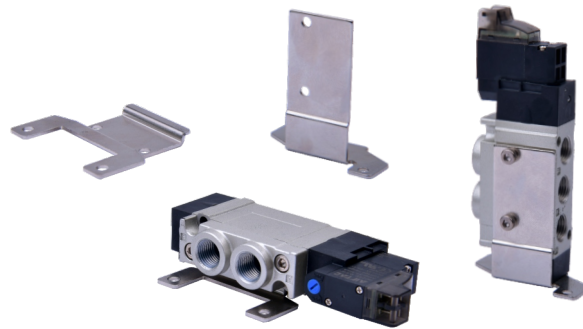

### Ordering code

**F-7V100 LB**

①      ②      ③

① <b>Accessories code</b>	F: Mounting accessories		
② <b>Valve type</b>	7V0500: 0500 Series	7V100: 100 Series	7V200: 200 Series
③ <b>Accessories type</b>	LB: LB Type(Side mounted)    LBD: LB Type(Bottom mounted)		

Note : 1、 Each mounting bracket with 4pcs mounting screws.  
2、 Packed in PE bags with blank labels.

### Dimensions

#### Side mounted

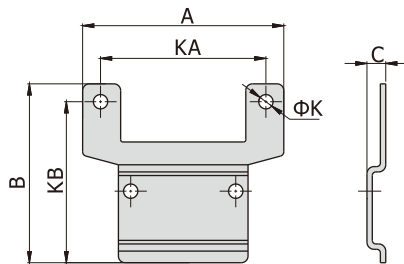

[Unit: mm]

Model\Item	A	B	C	K	KA	KB
F-7V0500LB	35	35	4.2	3.2	27	31.5
F-7V100LB	45	40	4.2	3.2	37	36
F-7V200LB	66	49	4.2	4.2	52	42

#### Bottom mounted

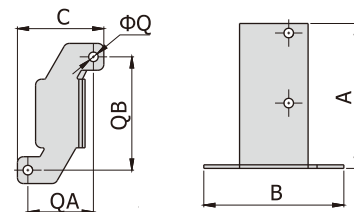

[Unit: mm]

Model\Item	A	B	C	Q	QA	QB
F-7V0500LBD	32.5	38	24	3.2	17	31
F-7V100LBD	48.5	47	29	3.2	22	38
F-7V200LBD	57	57	38	4.2	28	46

# Solenoid valve(5/2 way,5/3 way)

## Manifold for 7V series

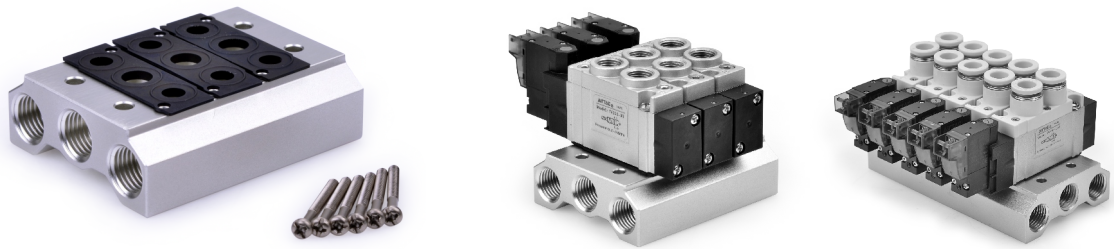

### Ordering code

Ordering code for manifold

**7V100M 5F T**

①

②

③

① <b>Model</b>	7V0500M: 7V0500 Series manifold	7V100M: 7V100 Series manifold	7V200M: 7V200 Series manifold	7V300M: 7V300 Series manifold
② <b>Number of stations</b>	1F: 1 Station    2F: 2 Station    3F: 3 Station    .....    20F: 20 Station			
③ <b>Thread type</b>	T: NPT			

Ordering code for blank plate

**P-7V100M-R2**

①

②

① <b>Model</b>	7V0500M: 7V0500 Series manifold	7V100M: 7V100 Series manifold	7V200M: 7V200 Series manifold	7V300M: 7V300 Series manifold
② <b>Code</b>	R2: Blank plate for manifold			

[Note] 1.Manifold kits contains manifold, seal and screw; 2. Blank plate kits contains blank plate and screw.

### Specification

Item \ Manifold Model	7V0500M	7V100M	7V200M	7V300M
Fluid	Air(to be filtered by 40µm filter element)			
Temperature	-20~70°C			
Adaptable valve's series	7V0500 Series	7V100 Series	7V200 Series	7V300 Series

### Product feature

1. It is available to integrate the direction control valves of the same series to form valve group to save space and cost.
2. It is easy to examine when there are faults owing to the unified air intake and exhaust and unified wiring.
3. Flexible combination and strong expansion capability can make any combination or expansion of the numbers of direction control valves that are connected.

# Solenoid valve(5/2 way,5/3 way)

## Manifold for 7V series

### Dimensions

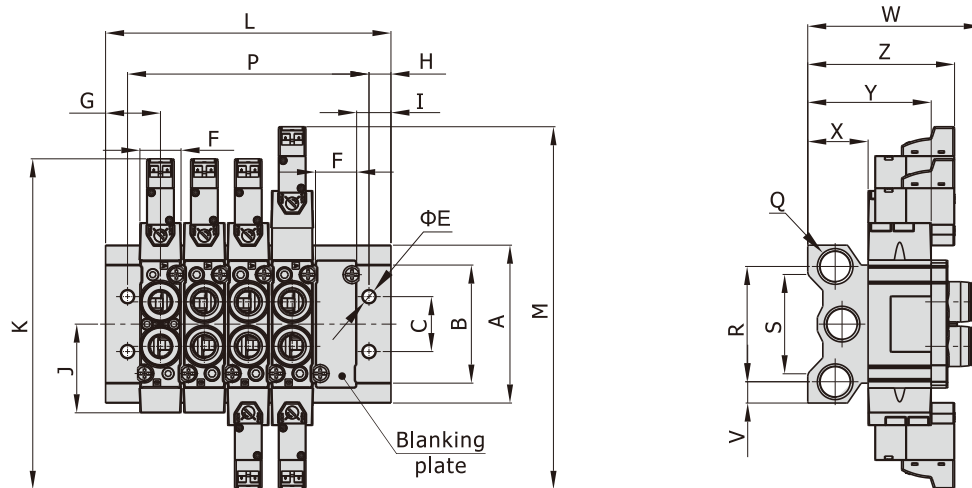

[Unit: mm]

Model\Item	A	B	C	E	F	G	H	I	J	K	M	Q	R	S	V	W			X	Y	Z	
7V0500M	46	32	16	4.5	10	17.5	7.5	12.5	22.5	102	110	1/8"	32	26	7	36.2(M5)	50.5(J5/32)			17	35.5	47.5
7V100M	57.5	43	20	4.5	15	20	8	12.5	32	121	132	1/4"	40	36	9	55(06)	62.5(J5/32) 64(J1/4)	65.5(J5/16)	22	45	53.5	
7V200M	60	52	21	4.5	18	22	8.5	13	39	134	147	1/4"	42	38	9	58.5(08)	76.5(J5/16)	78.5(J3/8)	24	52	57	
7V300M	85	75	26	4.5	23.5	24	5	12	54	167	185	3/8"	57	58	14	-	-	-	27	74	-	

Model\Item	L																			
	1F	2F	3F	4F	5F	6F	7F	8F	9F	10F	11F	12F	13F	14F	15F	16F	17F	18F	19F	20F
7V0500M	35	40.5	51	61.5	72	82.5	93	103.5	114	124.5	135	145.5	156	166.5	177	187.5	198	208.5	219	229.5
7V100M	40	50	66	82	98	114	130	146	162	178	194	210	226	242	258	274	290	306	322	338
7V200M	44	56	75	94	113	132	151	170	189	208	227	246	265	284	303	322	341	360	379	398
7V300M	48	72	96	120	144	168	192	216	240	264	288	312	336	360	384	408	432	456	480	504

Model\Item	P																			
	1F	2F	3F	4F	5F	6F	7F	8F	9F	10F	11F	12F	13F	14F	15F	16F	17F	18F	19F	20F
7V0500M	20	30.5	41	51.5	62	72.5	83	93.5	104	114.5	125	135.5	146	156.5	167	177.5	188	198.5	209	219.5
7V100M	24	40	56	72	88	104	120	136	152	168	184	200	216	232	248	264	280	296	312	328
7V200M	27	46	65	84	103	122	141	160	179	198	217	236	255	274	293	312	331	350	369	388
7V300M	38	62	86	110	134	158	182	206	230	254	278	302	326	350	374	398	422	446	470	494