



# Mini cylinder—MF Series

## Compendium of MF Series

**Multi-mounting accessories**

LB Type      FA Type      SDB Type      TC Type

**Rolling packed structure**

Front and back cover and stainless steel block adopt riveted rolling packed structure to form a reliable connection.

**Four bore size are available**

Bore size: 20, 25, 32, 40

**Three kinds of back cover type**

CA: Pivot type      U: Flat-end type      CM: Round-end type

**Multi-type cylinder**

MF: Mini cylinder(Double acting)

MSF: Mini cylinder (Single acting\_push)      MTF: Mini cylinder (Single acting\_pull)

MFD: Mini cylinder(Double rod)

MFJ: Mini cylinder(Adjustable stroke)

MFC: Mini cylinder(Double acting with cushion)

MFCD: Mini cylinder(Double rod with cushion)

MFCJ: Mini cylinder(Adjustable stroke with cushion)

**Two kinds of cushion type**

Variable cushion or Bumper

### Criteria for selection: Cylinder thrust

Unit : Newton(N)

Bore size	Rod size	Acting type	Pressure area(mm <sup>2</sup> )	Operating pressure(MPa)							
				0.1	0.2	0.3	0.4	0.5	0.6	0.7	
20	8	Single acting	Push side	314.0	-	24.3	55.7	87.1	117.5	149.9	181.3
			Pull side	263.8	-	14.3	40.6	67.0	93.4	119.8	146.1
		Double acting	Push side	314.0	31.4	62.8	94.2	125.6	157.0	188.4	219.8
			Pull side	263.8	26.4	52.8	79.1	105.5	131.9	158.3	184.7
25	10	Single acting	Push side	490.6	-	45.6	94.7	143.8	192.8	241.9	290.9
			Pull side	412.1	-	29.9	71.1	112.4	153.6	194.8	236.0
		Double acting	Push side	490.6	49.1	98.1	147.2	196.2	245.3	294.4	343.4
			Pull side	412.1	41.2	82.4	123.6	164.8	206.1	247.3	288.5
32	12	Single acting	Push side	804.3	-	82.2	162.6	242.9	323.3	403.7	484.1
			Pull side	691.2	-	59.6	128.6	197.7	266.8	335.9	405.0
		Double acting	Push side	804.3	80.4	160.9	241.3	321.7	402.2	482.6	563.0
			Pull side	691.2	69.1	138.2	207.4	276.5	345.6	414.7	483.8
40	16	Single acting	Push side	1256.6	-	158.5	284.1	409.7	535.3	660.9	786.5
			Pull side	1055.6	-	118.3	223.8	329.3	434.8	540.3	645.8
		Double acting	Push side	1256.6	125.7	251.3	377.0	502.6	628.3	754.0	879.6
			Pull side	1055.6	105.6	211.1	316.7	422.2	527.8	633.4	738.9

### Installation and application



- When load changes in the work, the cylinder with abundant output capacity shall be selected.
- Relative cylinder with high temperature resistance or corrosion resistance shall be chosen under the condition of high temperature or corrosion.
- Necessary protection measure shall be taken in the environment with higher humidity, much dust or water drops, oil dust and welding dregs.
- Dirty substances in the pipe must be eliminated before cylinder is connected with pipeline to prevent the entrance of particles into the cylinder.
- The medium used by cylinder shall be filtered to 40μm or below.
- Anti-freezing measure shall be adopted under low temperature environment to prevent moisture freezing.
- The cylinder shall be carried out test run without load before application. Prior to run, buffer shall be turned to the minimum and gradually released to avoid the damage on cylinder caused by excessive impact.
- To avoid side load, otherwise, piston rod will be bent and deformed and damage the thread at the end of the rod. Single-acting type can not be added in return.
- If the cylinder is dismantled and stored for a long time, please conduct anti-rust treatment to the surface. Anti-dust caps shall be added in air inlet and outlet ports. The front and back cover can not be dismantled, which shall be especially noticed.



# Mini cylinder

## MF Series



### Symbol

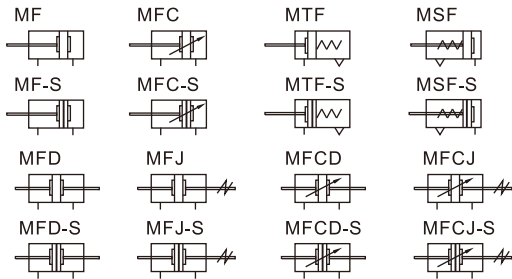

### Product feature

- JIS standard is implemented.
- Piston adopts heterogeneous two way seal structure. It has compact size and has the function of oil reservation.
- Front cover owns fixed anti-impact pad which can reduce the impact of direction-change of the cylinder.
- There are several modes of back cover, which makes the installation of cylinder more convenient.
- Front and back cover and stainless steel block adopt riveted rolling packed structure to form a reliable connection.
- The cylinder body has stainless steel pipes with high precision to produce high strength and corrosion resistance.
- With the same bore size and stroke, cylinders of MF series are shorter than ISO6432 standard cylinders.
- There are cylinders and mounting accessories with several specifications for your choice.

### Ordering code

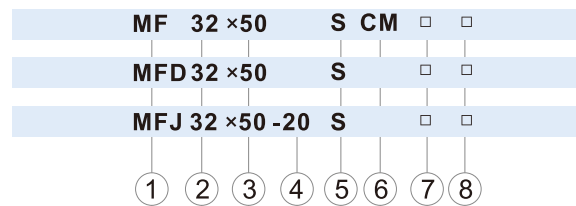

① Model	② Bore size	③ Stroke	④ Adjustable stroke	⑤ Magnet	⑥ Back cover	⑦ Mounting type[Note1]	⑧ Thread type
MF: Mini cylinder(Double acting) MFC: Mini cylinder (Double acting with cushion) MSF: Mini cylinder (Single acting_push) MTF: Mini cylinder (Single acting_pull)	20 25 32 40	Refer to stroke table for details	No this code	Blank: Without magnet S: With magnet	CA: Pivot type U: Flat-end type CM: Round-end type	Blank: No accessories FA: FA type SDB: SDB type LB: LB type TC: TC type	Blank: PT G: G T: NPT
MFD: Mini cylinder(Double rod) MFCJ: Mini cylinder (Double rod with cushion)  MFJ: Mini cylinder (Adjustable stroke) MFCJ: Mini cylinder (Adjustable stroke with cushion)			10 20 30 40 50 75 100		No this code	Blank: No accessories FA: FA type LB: LB type TC: TC type	

[Note1] Please refer to page 86~87 for accessory parts.

### Specification

Bore size(mm)	20	25	32	40
Acting type	Double acting、Double acting with cushion、Single acting			
Fluid	Air(to be filtered by 40μm filter element)			
Operating pressure	Double acting	0.15~1.0MPa(22~145psi)(1.5~10.0bar)		
	Single acting	0.2~1.0MPa(28~145psi)(2.0~10.0bar)		
Proof pressure	1.5MPa(215psi)(15bar)			
Temperature □	-20~70			
Speed range mm/s	Double acting : 30~800 Single acting : 50~800			
Stroke tolerance	0~150 <sup>+1.0</sup> <sub>0</sub> >150 <sup>+1.5</sup> <sub>0</sub>			
Cushion type	MFC/MFCD/MFCJ Series: Variable cushion; Other series: Bumper			
Port size [Note1]	1/8"			1/4"

[Note1] PT thread, G thread thread and NPT thread are available.  
Add) Refer to P353 for detail of sensor switch.

### Stroke

Bore size (mm)	Standard stroke (mm)																Max.std stroke	Max. stroke							
	20	15	20	25	30	40	50	60	75	80	100	125	150	160	175	200			250	300	350	400	450	500	
MF	20	10	15	20	25	30	40	50	60	75	80	100	125	150	160	175	200	250	300	350	400	450	500	500	800
	25	10	15	20	25	30	40	50	60	75	80	100	125	150	160	175	200	250	300	350	400	450	500	500	800
MFC	32	10	15	20	25	30	40	50	60	75	80	100	125	150	160	175	200	250	300	350	400	450	500	500	800
	40	10	15	20	25	30	40	50	60	75	80	100	125	150	160	175	200	250	300	350	400	450	500	500	800
MFD	20	10	15	20	25	30	40	50	60	75	80	100	125	150	160	175	200	250	300					300	-
MFCJ	25	10	15	20	25	30	40	50	60	75	80	100	125	150	160	175	200	250	300					300	-
MFJ	32	10	15	20	25	30	40	50	60	75	80	100	125	150	160	175	200	250	300	350	400	450	500	500	-
	40	10	15	20	25	30	40	50	60	75	80	100	125	150	160	175	200	250	300	350	400	450	500	500	-
MSF	20	10	15	20	25	30	40	50	60	75	80	100	125	150										-	-
	25	10	15	20	25	30	40	50	60	75	80	100	125	150										-	-
MTF	32	10	15	20	25	30	40	50	60	75	80	100	125	150										-	-
	40	10	15	20	25	30	40	50	60	75	80	100	125	150										-	-

[Note] Consult us for non-standard stroke.

## MF Series

### Inner structure and material of major parts

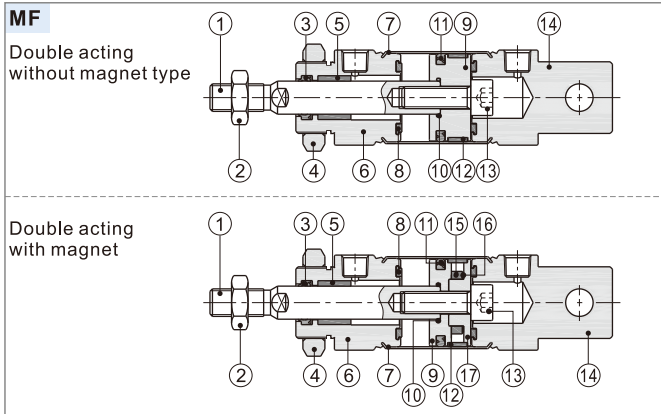

NO.	Item	Material
1	Piston rod	Carbon steel with 20μm chrome plated
2	Rod nut	Carbon steel
3	Front cover packing	NBR
4	Front cover nut	Carbon steel
5	Bushing	Wear resistant material
6	Front cover	Aluminum alloy
7	Barrel	SUS304
8	Bumper	TPU
9	Piston	Aluminum alloy
10	O-ring	NBR
11	Piston seal	NBR
12	Wear ring	Wear resistant material
13	Screw	Carbon steel
14	Back cover	Aluminum alloy
15	Magnet	Sintered metal (Neodymium-iron-boron)
16	Magnet washer	NBR
17	Magnet holder	Aluminum alloy

### Dimensions

#### MF\MFC

##### CM Type

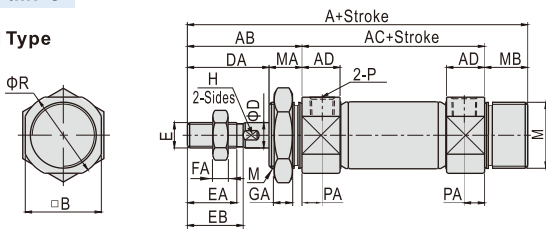

##### CA Type

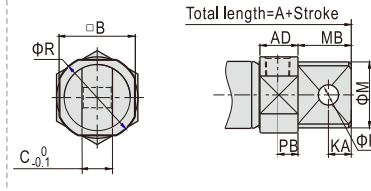

##### U Type

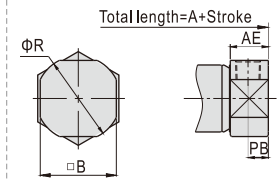

Bore size\Item Back cover	A			AB	AC	AD	AE	B	C	M				D	DA	E	EA	EB	F	FA	G	GA	H	K	KA	P	PA	PB	R	
	CM	CA	U							CM	CA	MA	CA																	CM
20	116	124	103	41	62	14.5	14.5	25	12	M20×1.5	20	14	21	13	8	27	M8×1.25	16.5	18	12	6	26	8	6	8	9	1/8"	7.5	7.5	29
25	120	128	108	45	62	14.5	15.5	30	12	M26×1.5	26	14	21	13	10	31	M10×1.25	20.5	22	17	6	32	8	8	8	9	1/8"	7.5	8	33.5
32	122	136	110	45	64	14.5	15.5	34.5	20	M26×1.5	26	14	27	13	12	31	M10×1.25	20.5	22	17	6	32	8	10	10	12	1/8"	7.5	8	37.5
40	154	165	138	50	88	21.5	22	42.5	20	M32×2.0	32	16	27	16	16	34	M14×1.5	22.5	24	19	8	41	10	14	10	12	1/4"	11	11.5	46.5

Remark :

- The dimensions of magnet type cylinder are the same as non-magnet type cylinder.
- The dimensions of MFC series are the same as MF series.

#### MSF

##### CM Type

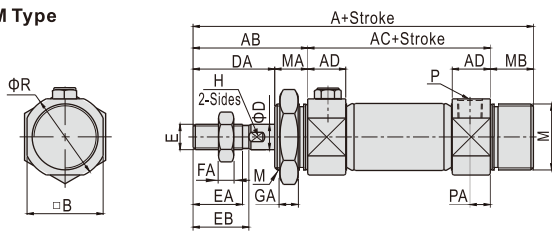

##### CA Type

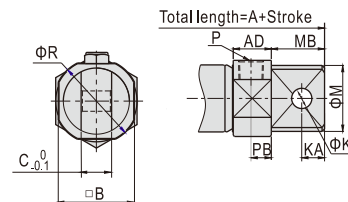

##### U Type

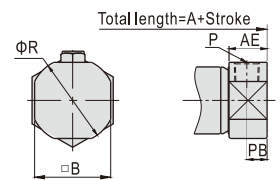

Bore size\Item Back cover	A			AC		
	CM			U		
Stroke	1~50	51~100	101~150	1~50	51~100	101~150
20	141	166	191	149	174	199
25	145	170	195	153	178	203
32	147	172	197	161	186	211
40	179	204	229	190	215	240

Bore size\Item Back cover	AB	AD	AE	B	C	D	DA	E	EA	EB	F	FA	G	GA	H	K	KA	M				P	PA	PB	R	
																		CM	CA	MA	CA					CM
20	41	14.5	14.5	25	12	8	27	M8×1.25	16.5	18	12	6	26	8	6	8	9	M20×1.5	20	14	21	13	1/8"	7.5	7.5	29
25	45	14.5	15.5	30	12	10	31	M10×1.25	20.5	22	17	6	32	8	8	8	9	M26×1.5	26	14	21	13	1/8"	7.5	8	33.5
32	45	14.5	15.5	34.5	20	12	31	M10×1.25	20.5	22	17	6	32	8	10	10	12	M26×1.5	26	14	27	13	1/8"	7.5	8	37.5
40	50	21.5	22	42.5	20	16	34	M14×1.5	22.5	24	19	8	41	10	14	10	12	M32×2.0	32	16	27	16	1/4"	11	11.5	46.5

Remark : The dimensions of magnet type cylinder are the same as non-magnet type cylinder.

# Mini cylinder

## MF Series

### MTF

#### CM Type

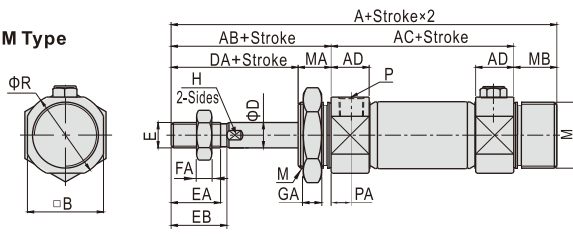

#### CA Type

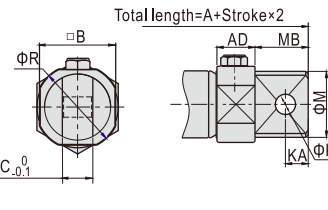

#### U Type

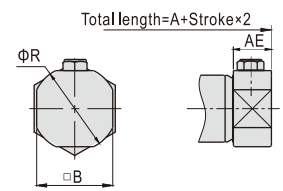

Bore size\Item	CM			A			U			AC			M	MA	MB		
Back cover	CM			CA			U			-			CM	CA	-	CA	CM
Stroke	1~50	51~100	101~150	1~50	51~100	101~150	1~50	51~100	101~150	1~50	51~100	101~150	-	-	-	-	-
20	141	166	191	149	174	199	128	153	178	87	112	137	M20×1.5	20	14	21	13
25	145	170	195	153	178	203	133	158	183	87	112	137	M26×1.5	26	14	21	13
32	147	172	197	161	186	211	135	160	185	89	114	139	M26×1.5	26	14	27	13
40	179	204	229	190	215	240	163.5	188.5	213.5	113	138	163	M32×2.0	32	16	27	16

Bore size\Item	AB	AD	AE	B	C	D	DA	E	EA	EB	F	FA	G	GA	H	K	KA	P	PA	R
20	41	14.5	14.5	25	12	8	27	M8×1.25	16.5	18	12	6	26	8	6	8	9	1/8"	7.5	29
25	45	14.5	15.5	30	12	10	31	M10×1.25	20.5	22	17	6	32	8	8	8	9	1/8"	7.5	33.5
32	45	14.5	15.5	34.5	20	12	31	M10×1.25	20.5	22	17	6	32	8	10	10	12	1/8"	7.5	37.5
40	50	21.5	22	42.5	20	16	34	M14×1.5	22.5	24	19	8	41	10	14	10	12	1/4"	11	46.5

Remark : The dimensions of magnet type cylinder are the same as non-magnet type cylinder.

### MFJ/MFCJ

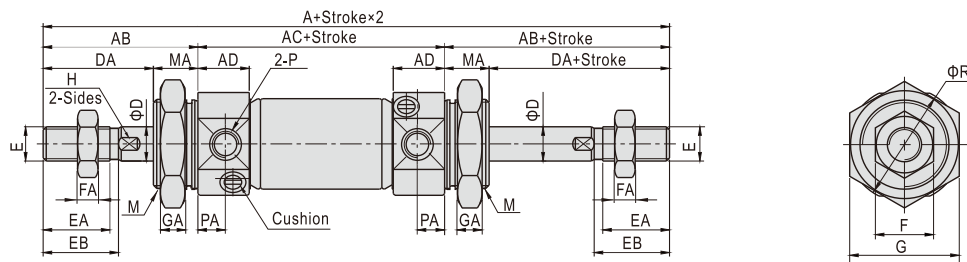

### MFJ/MFCJ

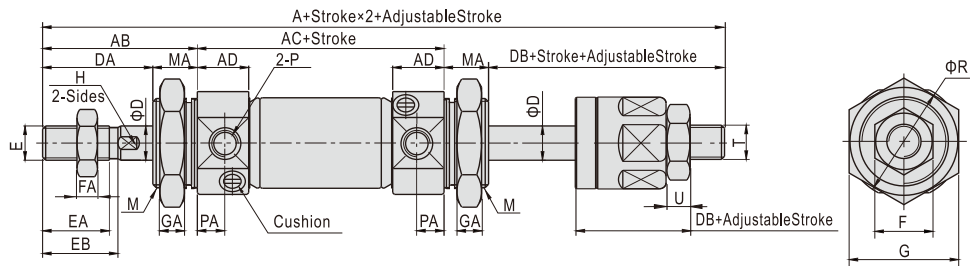

Bore size\Item	A		AB	AC	AD	D	DA	DB	E	EA	EB	F	FA	G	GA	H	M	MA	P	PA	R	T	U
	MFD\MFCD	MFJ\MFCJ																					
20	144	141	41	62	14.5	8	27	24	M8×1.25	16.5	18	12	6	26	8	6	M20×1.5	14	1/8"	7.5	29	M8×1.25	5
25	152	148	45	62	14.5	10	31	27	M10×1.25	20.5	22	17	6	32	8	8	M26×1.5	14	1/8"	7.5	33.5	M10×1.25	6
32	154	150	45	64	14.5	12	31	27	M10×1.25	20.5	22	17	6	32	8	10	M26×1.5	14	1/8"	7.5	37.5	M10×1.25	6
40	188	182	50	88	21.5	16	34	28	M14×1.5	22.5	24	19	8	41	10	14	M32×2.0	16	1/4"	11	46.5	M12×1.25	7

Remark : The dimensions of magnet type cylinder are the same as non-magnet type cylinder.

# Mini cylinder

## MF Series—Accessories

### List for ordering code of accessories

Accessories Bore size	Mounting accessories				Knuckle				Sensor switch		
	LB	FA	TC	SDB	I	Y	F	U	CMSG	DMSG	EMSG
20	F-MF20LB	F-MF20FA	F-MF20TC	F-MF20SDB	F-MF20I	F-MF20Y	F-M8X125F	F-M8X125U	CMSG	DMSG	EMSG
25	F-MF32LB	F-MF32FA	F-MF32TC		F-MF25I	F-MF25Y	F-M10X125F	F-M10X125U			
32	F-MF40LB	F-MF40FA	F-MF40TC	F-MF32SDB	F-MF40I	F-MF40Y	F-M14X150F	F-M14X150U			

### Accessory selection

Cylinder model	Accessories	Mounting accessories				Knuckle				Sensor switch		
		LB	FA	SDB	TC	I	Y	U [1]	F	CMSG	DMSG	EMSG
MF	Standard	●	●	●	●	●	●	●	●	×	×	×
MFC	With magnet	●	●	●	●	●	●	●	●	●	●	●
MSF	Standard	●	●	●	●	●	●	●	●	×	×	×
MTF	With magnet	●	●	●	●	●	●	●	●	●	●	●
MFD	Standard	●	●	×	●	●	●	●	●	×	×	×
MFCJ	With magnet	●	●	×	●	●	●	●	●	●	●	●
MFJ	Standard	●	●	×	●	●	●	●	●	×	×	×
MFCJ	With magnet	●	●	×	●	●	●	●	●	●	●	●

### Material of accessories

Accessories Bore size	Mounting accessories				Knuckle				Sensor switch		
	LB	FA	SDB	TC	I	Y	F	U	CMSG	DMSG	EMSG
20~40	△	△	△	■	□	□	□	□	□	□	□

■—Cast steel ; △—SPCC ; □—Carbon steel

[Note 1] Please refer to P349~352 for knuckle detail.

### Dimensions

#### LB

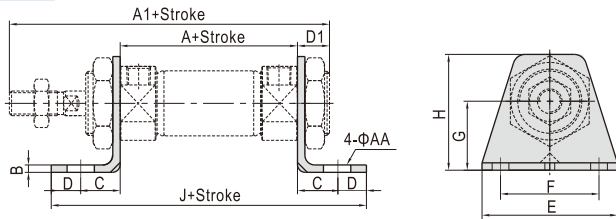

Bore size\Item	A	A1	AA	B	C	D	D1	E	F	G	H	J
20	62	116	7	3	20	8	13	55	40	25	40	118
25	62	120	7	3.5	20	8	13	55	40	28	47	118
32	64	122	7	3.5	20	8	13	55	40	28	47	120
40	88	154	7	3.5	23	10	16	75	55	30	54	154

#### SDB

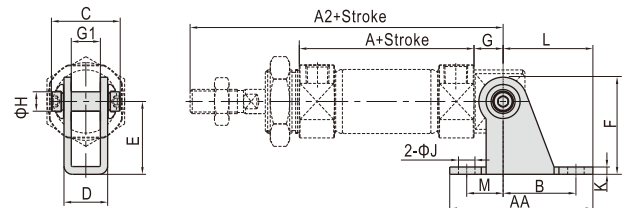

Bore size\Item	A	A2	AA	B	C	D	E	F	G	G1	H	K	J	L	M
20	62	115	59	30	31	17.1	30	40	12	12.1	8	2.5	7	37	15
25	62	119	59	30	31	17.1	30	40	12	12.1	8	2.5	7	37	15
32	64	124	75	40	42	26.1	40	53	15	20.1	10	3	9	50	15
40	88	153	75	40	42	26.1	40	53	15	20.1	10	3	9	50	15

[Note] SDB is attached with relevant PIN.

#### FA

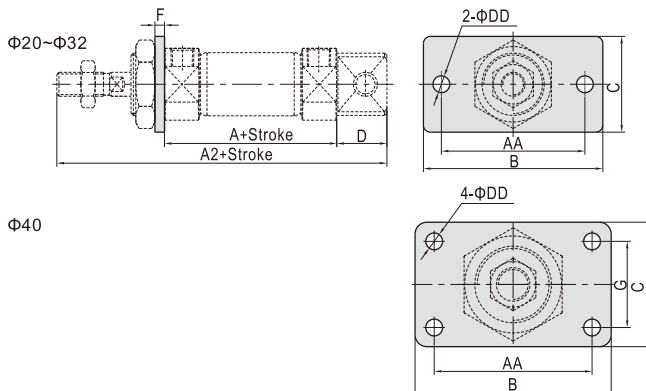

Bore size\Item	A	A2	AA	B	C	D	DD	F	G
20	62	124	60	75	34	21	7	3.5	-
25	62	128	60	75	40	21	7	4	-
32	64	136	60	75	40	27	7	4	-
40	88	165	66	82	52	27	7	4	36

#### TC

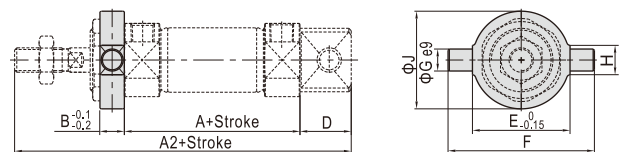

Bore size\Item	A	A2	B	D	E	F	G	H	J
20	62	124	10	21	32	52	8	12	32
25	62	128	10	21	40	60	9	12	40
32	64	136	10	27	40	60	9	12	40
40	88	165	11	27	53	77	10	14	53

#### Special nut for TC

Bore size\Item	A	B	C	D	E
20	26	28	8	25	M20×1.5
25	32	34	8	31	M26×1.5
32	32	34	8	31	M26×1.5
40	41	45	10	40	M32×2.0

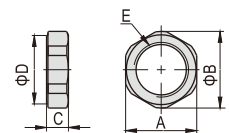

# Mini cylinder

## MF Series—Accessories

### I Knuckle

F-MF20I, F-MF25I

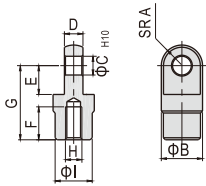

F-MF40I

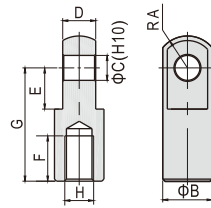

Type\Item	A	B	C	D	E	F	G	H	I
F-MF20I	9.5	20	9	9	14	16	36	M8×1.25	18
F-MF25I	9.5	20	9	9	14	18	38	M10×1.25	18
F-MF40I	15	24	12	16	20	22	55	M14×1.5	-

### Y Knuckle

F-MF20Y  
F-MF25Y

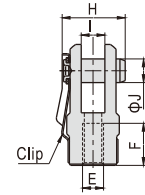
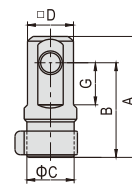

F-MF40Y

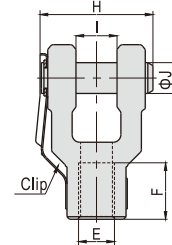
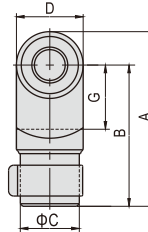

Type\Item	A	B	C	D	E	F	G	H	I	J
F-MF20Y	46	36	18	17.5	M8×1.25	16	16	24	9	9
F-MF25Y	48	38	18	17.5	M10×1.25	18	16	24	9	9
F-MF40Y	68	55	23	26	M14×1.5	22	25	44	16	12